



Drawing No.	*Rev.	Date	Page
SL1411A-DWW-LF064C0-11301	F	2017/01/06	1/12

LED APPROVAL SHEET

Part No: SL1411A-DWW-LF064C0-11301

Customer Part No: 008-9002-09

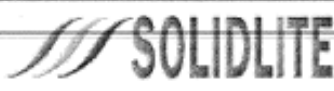
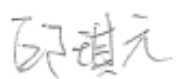
NOTE :
Tri-Wavelength White LED
Green Part

MAKER			CUSTOMER	
				
R&D	QA	Sales	Checked	Approved
				

Prepared	Checked	Approved
Rachel Lee	Hann Chiu	Kenneth Wu



Drawing No.	*Rev.	Date	Page
SL1411A-DWW-LF064C0-11301	F	2017/01/06	2/12

Change Sheet

Version	Date	Description
100	2010/6/8	Preliminary release
200	2010/10/12	Modified surface
300	2011/3/29	Modified surface
400	2014/4/30	Modified surface

Drawing No.	*Rev.	Date	Page
SL1411A-DWW-LF064C0-11301	F	2017/01/06	3/12

Description of P/N No.

SL1411A-D WW-LF064C0-11301

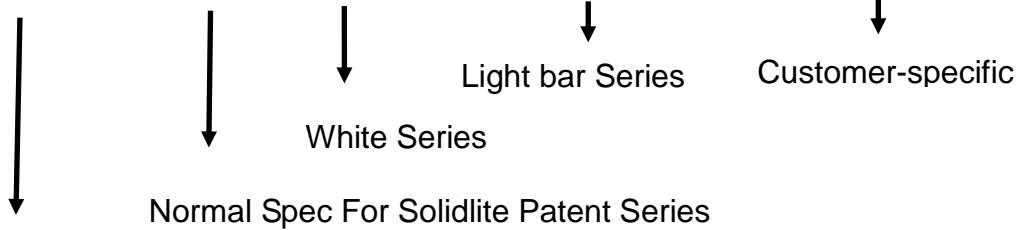

SOLIDLITE LED – TOP 1411 SMD-L/F – 1.9t

Description of Lot.

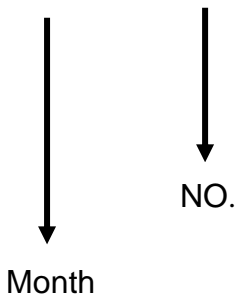
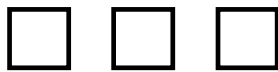

Solidlite Corp. 

P/N : _____

Lot : _____

Date: _____ . Rank: _____

Q'ty : _____ . QA _____

Description of Rank

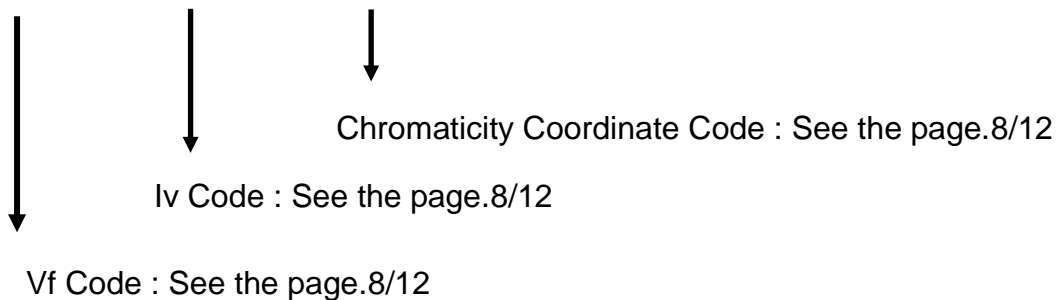

Absolute Maximum Ratings at $T_a=25^\circ\text{C}$

Parameter	MAX.	Unit
DC forward current	30	mA
Power Dissipation	105	mW
Pulse Current (1/10 duty, 10ms Pulse width)	100	mA
Reverse Voltage (V_R)	5	V
Electrostatic Discharge Classification(HBM)	$\pm 500\text{V}$	
Operating Temperature Range	-40°C to $+85^\circ\text{C}$	
Storage Temperature Range	-55°C to $+100^\circ\text{C}$	
Lead Soldering Temperature	245°C for 10 seconds	

Electrical and Optical Characteristics at $T_a=25^\circ\text{C}$

Parameter	Test Condition	Symbol	Min.	Typ.	Max.	Unit
Chromaticity Coordinate [#]	$I_F=20\text{mA}$	CIE-X	0.300	—	0.360	-
		CIE-Y	0.315	—	0.375	-
Forward Voltage	$I_F=20\text{mA}$	V_F	3.0	—	3.5	V
Reverse Current	$V_R=5\text{V}$	I_R	—	—	10	μA
Luminous Intensity	$I_F=20\text{mA}$	I_v	1200	—	1500	mcd
Viewing Angle	$I_F=20\text{mA}$	$2\theta_{1/2}$	—	120	—	deg

#:Please refer to CIE 1931 chromaticity diagram.

Recommend forward current for longer duration is 20mA.

These values measured by Optical Spectrum Analyzer of SOLIDLITE.

Package outline dimensions :

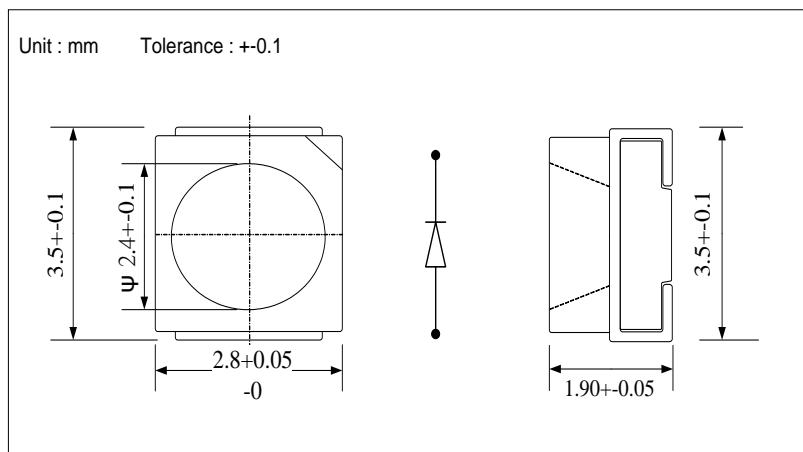

Recommended pad :

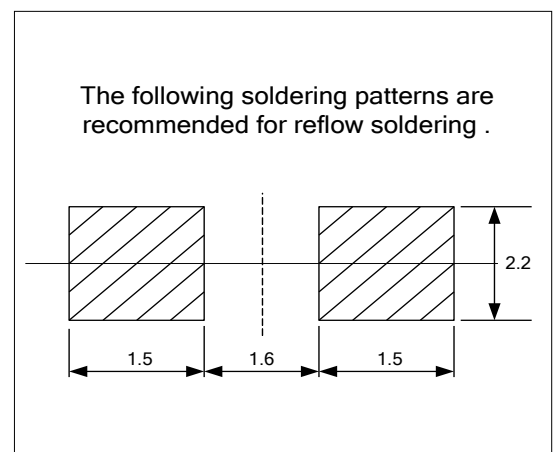

Drawing No.	*Rev.	Date	Page
SL1411A-DWW-LF064C0-11301	F	2017/01/06	5/12

LED Spectrum

This spectrum is for reference only. They are not absolute values and can not be a rule.

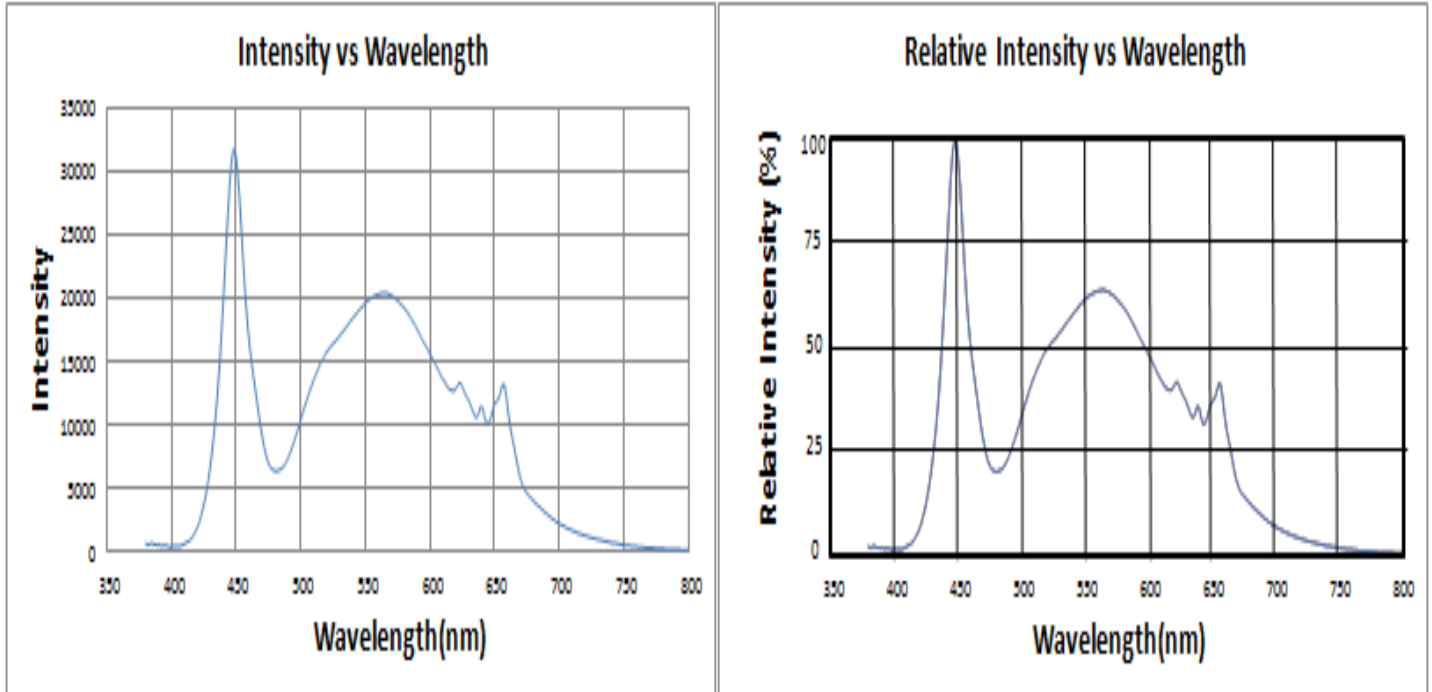

LED Spatial Distribution

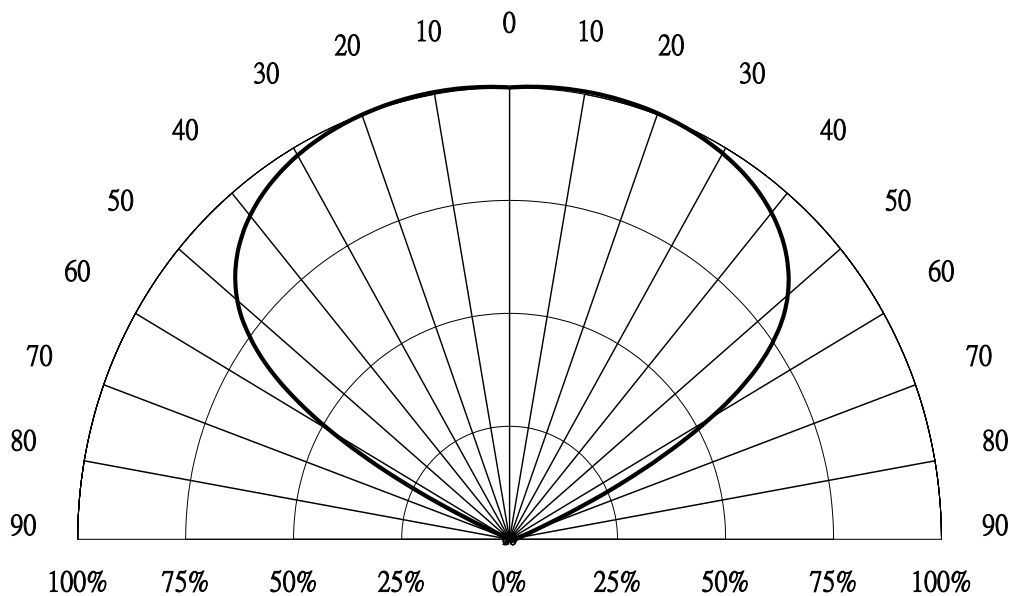

Typical Electrical / Optical Characteristics Curves

(25°C Ambient Temperature Unless Otherwise Noted)

Luminous Intensity vs. Ambient Temperature

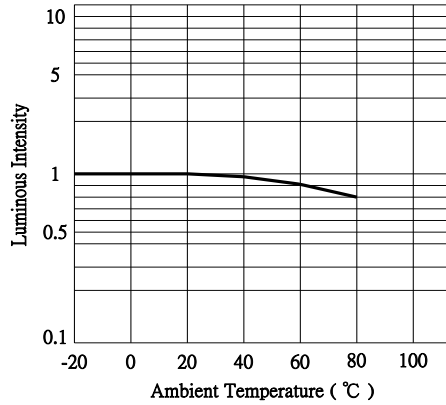

Relative Intensity vs. Forward Current

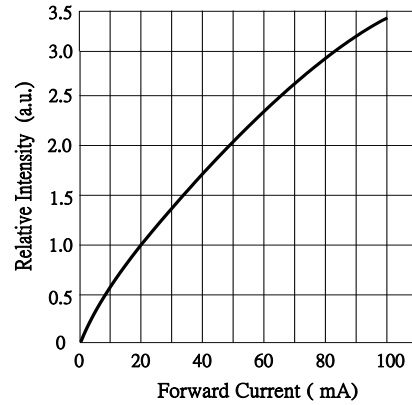

Forward Current vs. Ambient Temperature

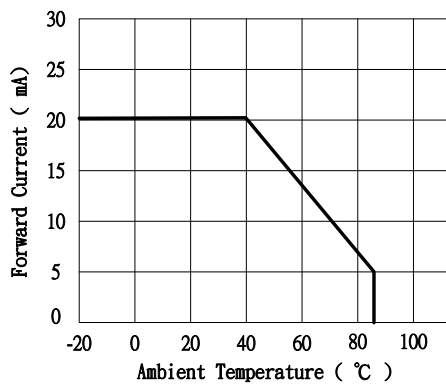

Forward Current vs. Forward Voltage

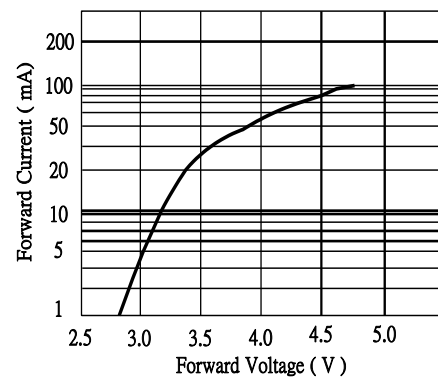

Duty Ratio vs. Allowable Forward Current

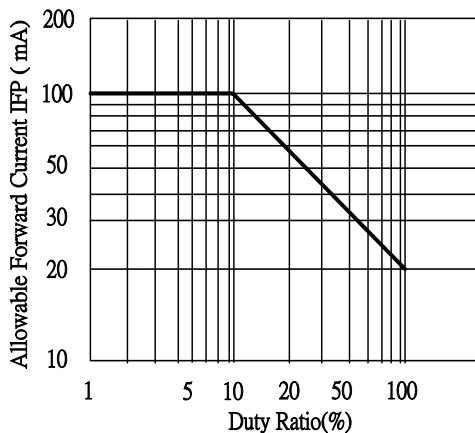

Forward Voltage vs. Ambient Temperature

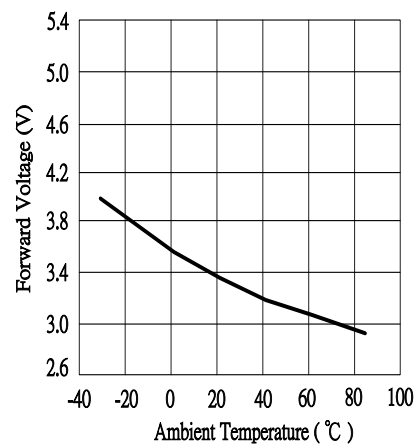

Surface Mounting Condition

In automatic mounting of the SMD LEDs on printed circuit boards, any bending, expanding and pulling forces or shock against the SMD LEDs shall be kept min. to prevent them from electrical failures and mechanical damages of the devices.

Soldering Reflow

Soldering of the SMD LEDs shall conform to the soldering condition in the individual specifications. SMD LEDs are designed for Reflow Soldering.

In the reflow soldering, too high temperature and too large temperature gradient such as rapid heating / cooling may cause electrical & optical failure and damages of the devices.

Solidlite can not guarantee the LED after they have been assembled using the solder dipping method.

commended Soldering Temperature Time Profile (Reflow Soldering)

Lead Free Solder	
Pre-heat	150~200 ℃
Pre-heat time	120 sec. Max.
Peak-Temperature	245 ℃ Max.
Soldering time Condition	10 sec. Max.

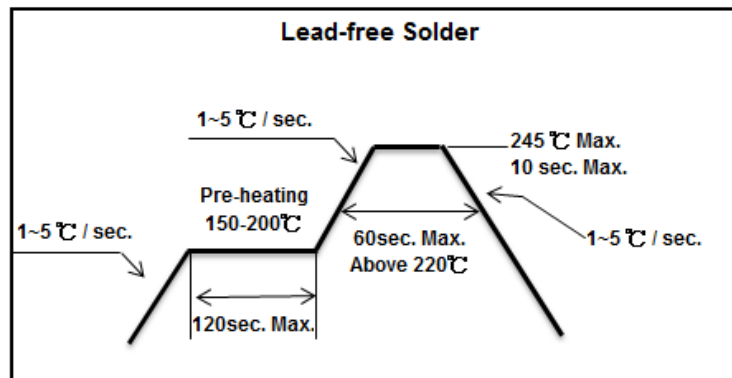

Reliability Test Item and Conditions

• Results of Reliability Test

No	Item	Test Condition	Test Hours/Cycles	Sample No	Ac / Re
1	DC Operating Life	$I_F : 20mA$	1,000 HRS	50 PCS	0 / 1
2	High Temperature Storage	Temp : 100℃	1,000 HRS	50 PCS	0 / 1
3	Low Temperature Storage	Temp : -55℃	1,000 HRS	50 PCS	0 / 1
4	Thermal Shock Test	-40℃ ↔ 80℃ 5min 8secs 5min	100 CYCLES	50 PCS	0 / 1
5	Temperature Cycle	-40℃~25℃~100℃~25℃ 30min 5min 30min 5min	300 CYCLES	50 PCS	0 / 1
6	Temp. & Humidity bias	$T_A=85℃, RH=85%$	1,000 HRS	50 PCS	0 / 1

• The Reliability Criteria of SMD LED

Item	Symbol	Test Condition	Limit	
			Min.	Max.
Forward Voltage	V_F	$I_F : 20mA$	-	U.S.L*1.1
Reverse Current	I_R	$V_R : 5V$	-	U.S.L*2
Luminous Intensity	I_V	$I_F : 20mA$	L.S.L.*0.5	-

*U.S.L. : Upper Standard Level *L.S.L. : Lower Standard Level

LED Ranks Combination

Vf(V)			Luminous Intensity(mcd)			W W(WHITE)				
Vf@20mA			Iv@20mA			Chromaticity Coordinate CIE(X/Y)@20mA				
Code	min	max	Code	min	max	Code	CIE-X / Y			
A2	3.0	3.1	BK	1200	1300	D7	(0.300,0.335)	(0.340,0.335)	(0.340,0.315)	(0.300,0.315)
A3	3.1	3.2	BL	1300	1400	D8	(0.310,0.355)	(0.350,0.355)	(0.350,0.335)	(0.310,0.335)
A4	3.2	3.3	BM	1400	1500	D9	(0.320,0.375)	(0.360,0.375)	(0.360,0.355)	(0.320,0.355)
A5	3.3	3.4	-	-	-	-	-	-	-	-
A6	3.4	3.5	-	-	-	-	-	-	-	-

#:Please refer to CIE 1931 chromaticity diagram.

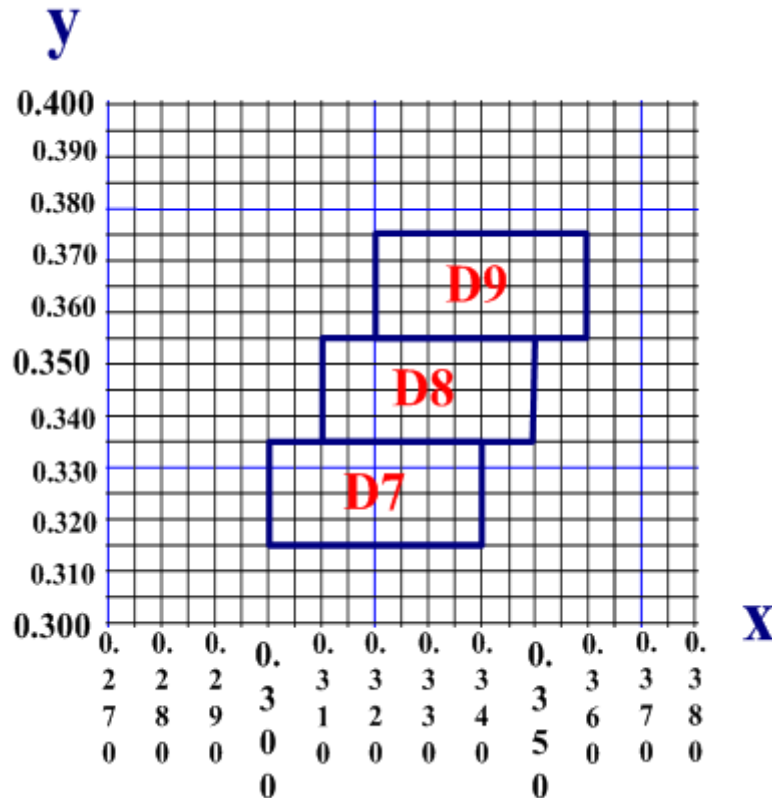

CIE X-Y:

D7---(0.300,0.335) (0.340,0.335) (0.340,0.315) (0.300,0.315)

D8---(0.310,0.355) (0.350,0.355) (0.350,0.335) (0.310,0.335)

D9---(0.320,0.375) (0.360,0.375) (0.360,0.355) (0.320,0.355)

C. LED Bar Data

Absolute Maximum Ratings at $T_a=25^\circ\text{C}$

Parameter	Symbol	Rating	Unit
Power Dissipation	Pd	4.6	W
D.C. Forward Current	If	320	mA
Electrostatic Discharge (ESD)	HBM	± 8000	V

Electrical and Optical Characteristics at $T_a=25^\circ\text{C}$

Parameter	Test Condition	Symbol	Min.	Typ.	Max.	Unit
Chromaticity Coordinate [#]	$I_F=320\text{mA}$	CIE-X	0.300	—	0.360	-
		CIE-Y	0.315		0.375	
Forward Current	$I_F=320\text{mA}$	Vf	12	—	14	V

#:Please refer to CIE 1931 chromaticity diagram.

Recommend forward current for longer duration is 320mA.

These values measured by Optical Spectrum Analyzer of SOLIDLITE.

Light Bar Brightness Test

Brightness	Min	Max
CCD output (Red)	65	155
CCD output (Green)	80	200
CCD output (Blue)	35	115

Drawing No.	*Rev.	Date	Page
SL1411A-DWW-LF064C0-11301	F	2017/01/06	10/12

LED Bar Dimension

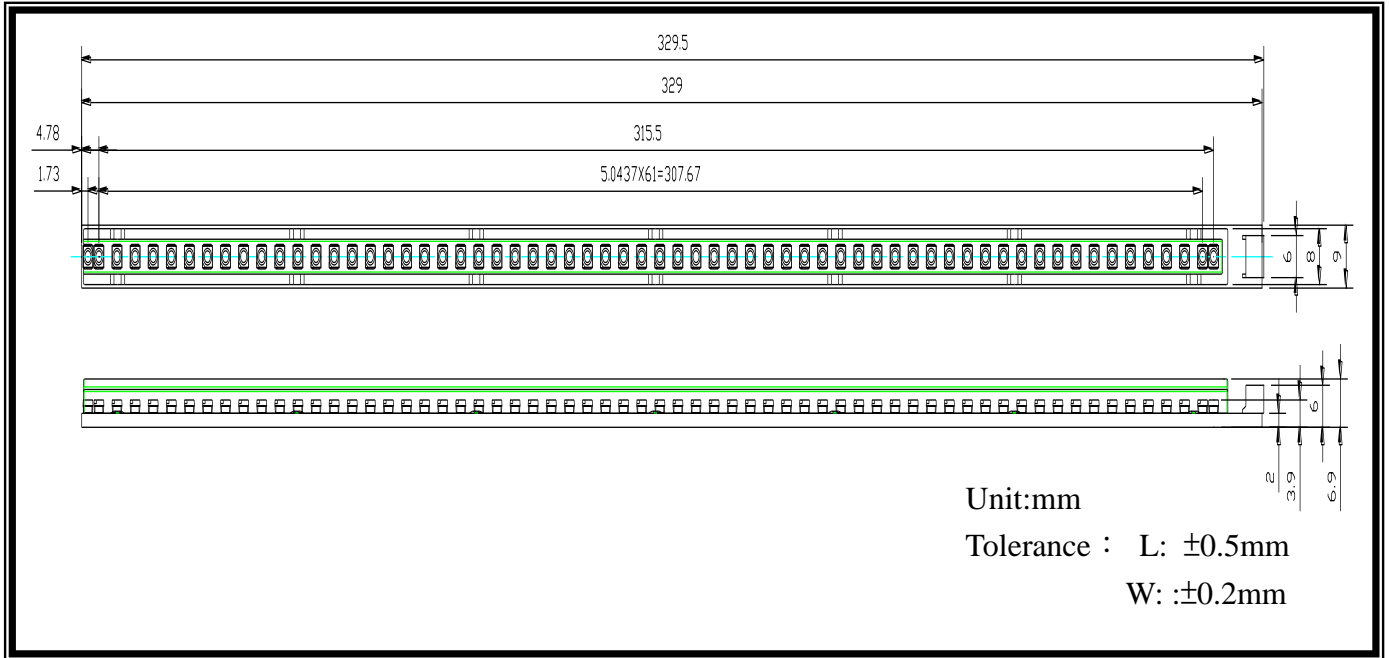

Typical Internal Equivalent Circuits

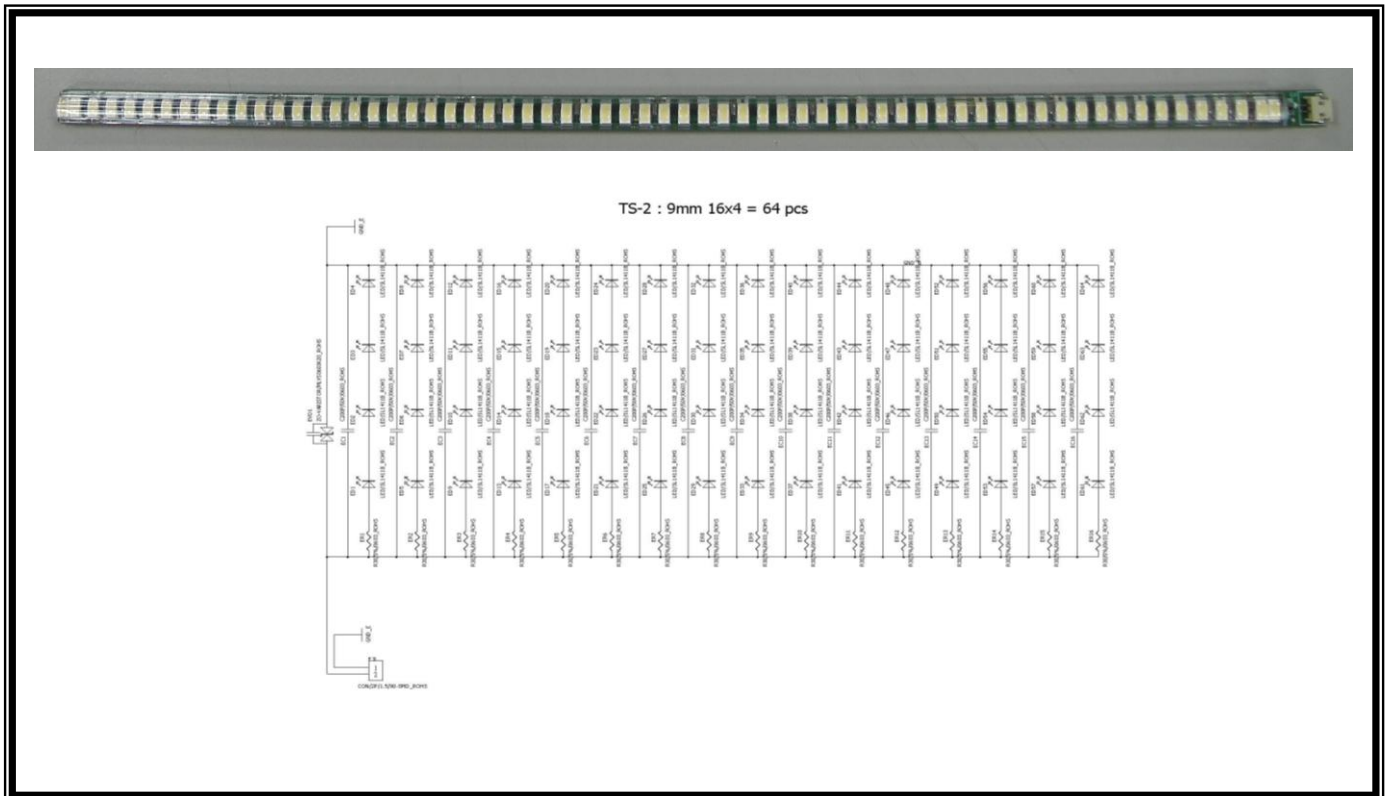

Drawing No.	*Rev.	Date	Page
SL1411A-DWW-LF064C0-11301	F	2017/01/06	11/12

D. LED Bar package information and Rohs

Packing Model

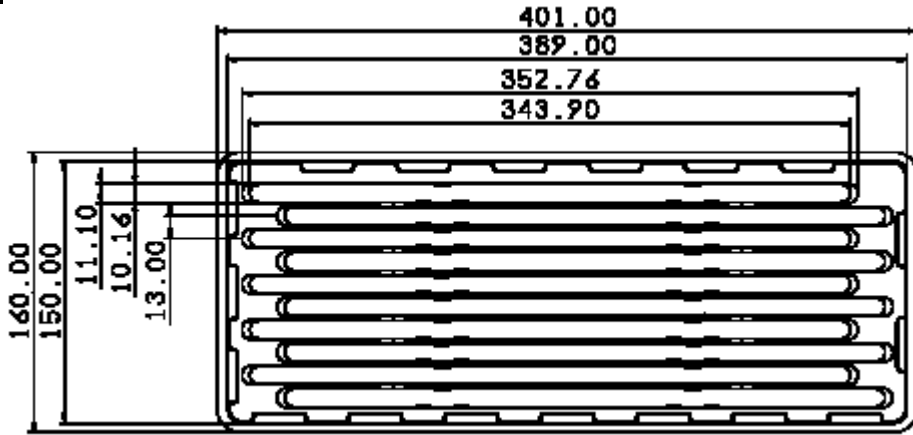

10pcs / Tray

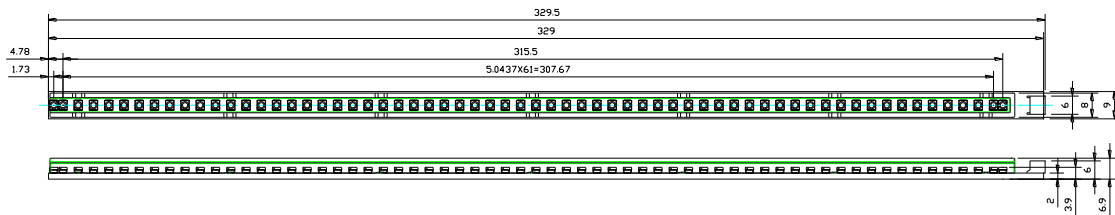

5Tray / Stack Stack:40pcs

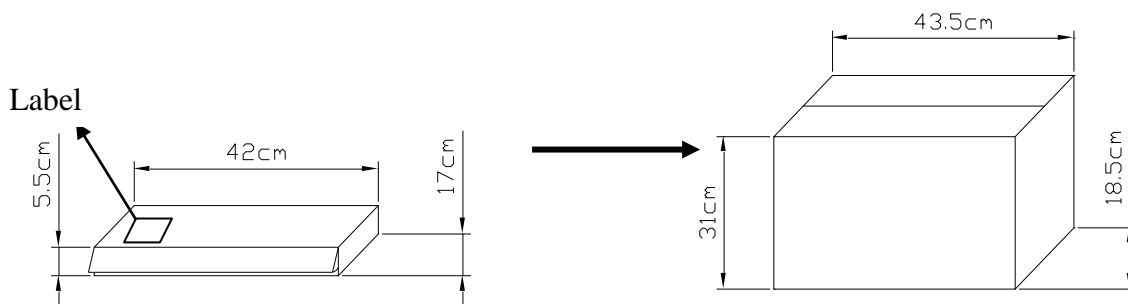

5 Small Carton / big Carton Total :200pcs

Drawing No.	*Rev.	Date	Page
SL1411A-DWW-LF064C0-11301	F	2017/01/06	12/12

LIGHT COVER 料號:051-4673-0

規格:319 (長)x8.36(寬)x5.32(高)

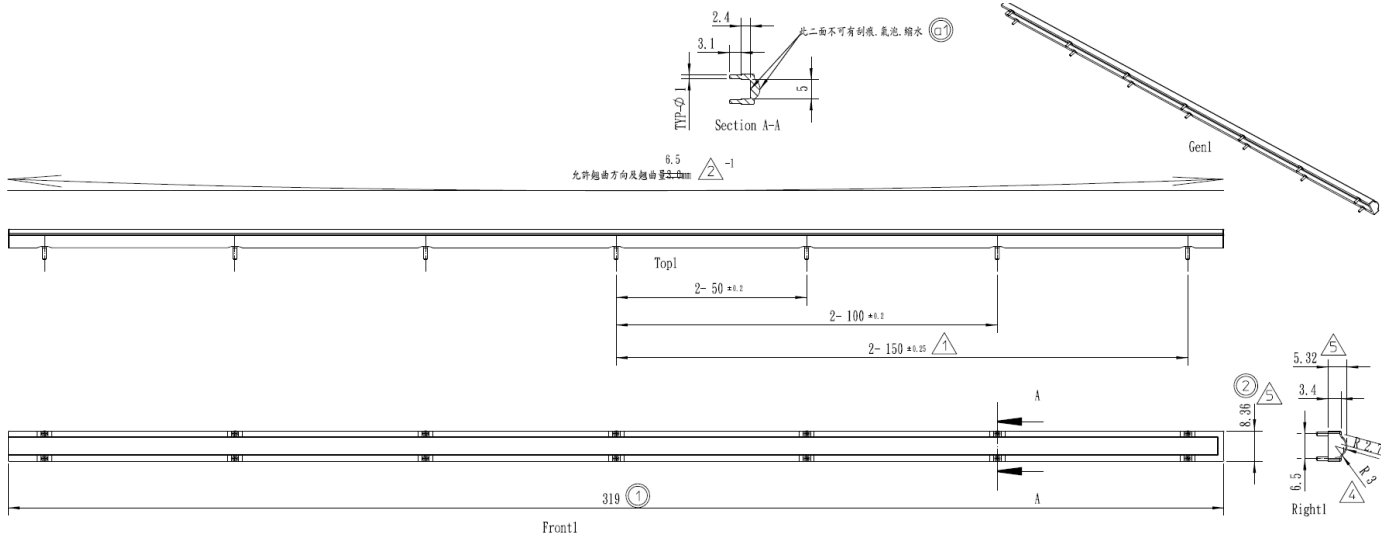

Notes:

1. 加工：射出成型

2. 檢查：(a) 實際重量：7.9g±1g (3)

(b) 外觀：1. 無感刮傷≤3mm

2. 黑點<0.3mm

3. 成品請參考虹光作業指導書

ISO-9001 塑膠件檢驗規範 A 級檢驗

(c) 尺寸

(i) 如未特別註明，標註方式依拔模角

之最大尺寸，如右圖

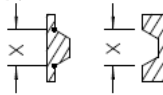

(ii) 未標註拔模角為 1°

(iii) 零件主體最小厚度：1.5 mm

(iv) 加註公差、幾何公差及文字敘述為重點尺寸

屬供應商出貨必檢項目

(v) (3) 為關鍵尺寸，共 5 處

屬虹光 SQA 進料抽驗項目

3. 成品須符合虹光公司環境管理物質要求

4. 包裝：(a) PE袋：1袋 100 cs

(b) 依P/O數量完封箱，包裝完後貼上標籤出貨