





Drawing No.	*Rev.	Date	Page
BF5H30G-YLR-050mA	A	2018/08/09	1/3

APPROVAL SHEET

Part No: **BF5H30G-YLR-050mA**

NOTE : **Green Part**

MAKER			CUSTOMER	
				
R&D	QA	Sales	Checked	Approved
				

Prepared	Checked	Approved
Rachel Lee	Sky Lin	Kenneth Wu

DESCRIPTION:

Device Type : BF5H30G-YLR-050mA
 Dice Material : AlGaAs
 Light Color : InfraRed 850nm
 Lens Color : Water Clear
 Lens Dimension : 5 mm

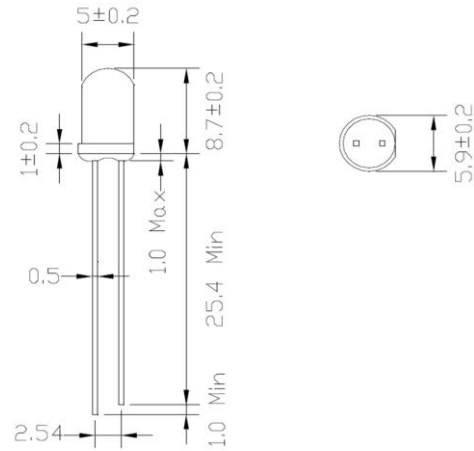

Absolute Maximum Ratings at Ta=25°C

Parameter	Max.	Unit
DC Forward Current	60	mA
Reverse Voltage	5	V
Power Dissipation	120	mW
Operating Temperature	Topr : -30 ~ +85	°C
Storage Temperature	Tstr : -40 ~ +100	°C
Solder DIP (MAX. 5 seconds, 1.6mm from body) Temperature 260°C		

Electrical and Optical Characteristics at Ta=25°C

Symbol	Description	Test Condition	Min.	Typ.	Max.	Unit
V _F	Forward Voltage	I _F = 50mA	-	1.6	2.0	V
I _R	Reverse Current	V _R = 5V	-	-	10	μA
λ _P	Peak Emission Wavelength	I _F = 50mA	-	850	-	nm
Δλ	Spectral Line Halfwidth	I _F = 50mA	-	40	-	nm
2θ _{1/2}	Viewing Angle	I _F = 50mA	-	30	-	Deg.
P _o	Radiant Power	I _F = 50mA	25	-	40	mW

- Note:
- 1.The lead should be formed up to 5mm from the body of device without forming stress.
 2. Soldering shall be performed after lead forming.
 3. All dimensions are in millimeters

LED LAMP Technical Data

Typical Optical-Electrical Characteristic Curves

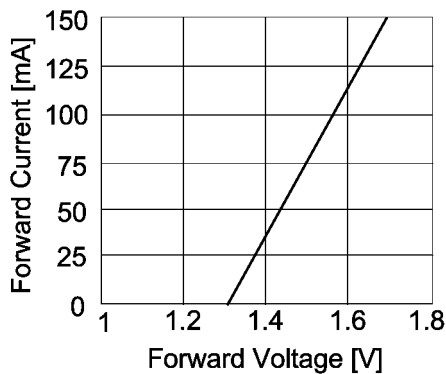

**Forward Current
Vs. Forward Voltage**

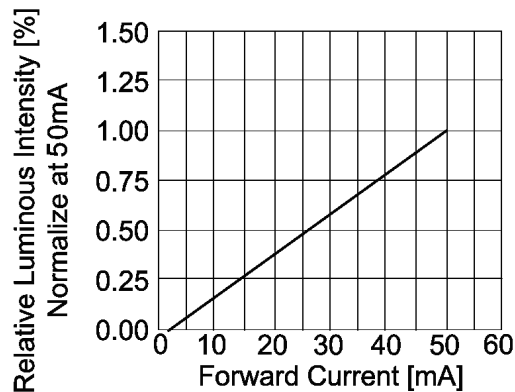

**Luminous Intensity
Vs. Forward Current**

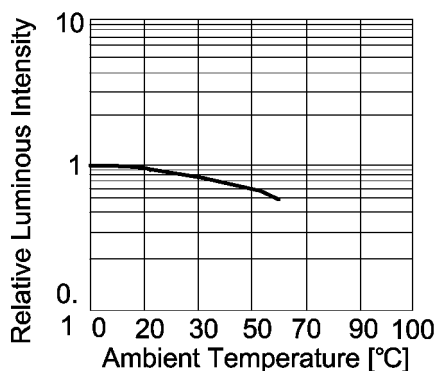

**Luminous Intensity
Vs. Ambient Temperature**

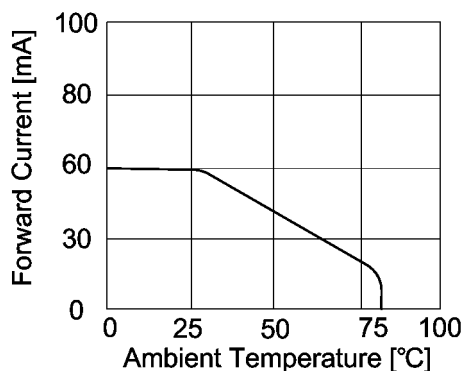

**Forward Current
Vs. Ambient Temperature**

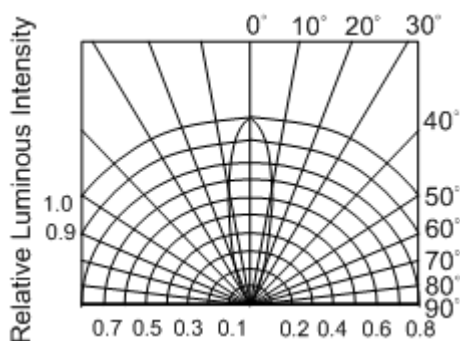

Radiation Pattern

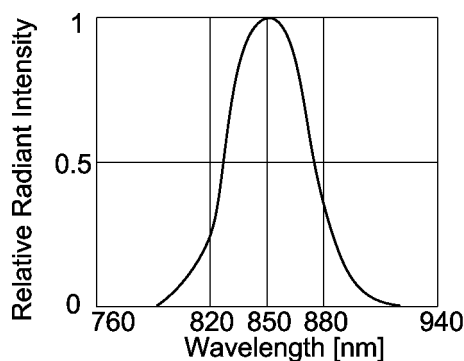

**Relative Luminous Intensity
Vs. Wavelength**