



Drawing No.	Rev.	Date	Page
AG3535C-YRR-1000mA-H1	A	2022/06/01	1/10

IRED APPROVAL SHEET

Part No: **AG3535C-YRR-1000mA-H1**

NOTE :
Green Part

MAKER			CUSTOMER	
R&D	QA	Sales	Checked	Approved

Prepared	Checked	Approved
Rachel Lee	Sky Lin/Sander Wu	Kenneth Wu



Drawing No.	Rev.	Date	Page
AG3535C-YRR-1000mA-H1	A	2022/06/01	2/10

Description of P/N No.

AG3535C - YRR - 1000mA - H1



Description of Lot.

□ □ □ □

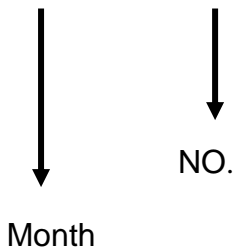

Solidlite Corp. 

P/N : _____

Lot : _____

Date: _____ . Rank: _____

Q'ty : _____ . QA _____

Description of Rank

□ □ □ □

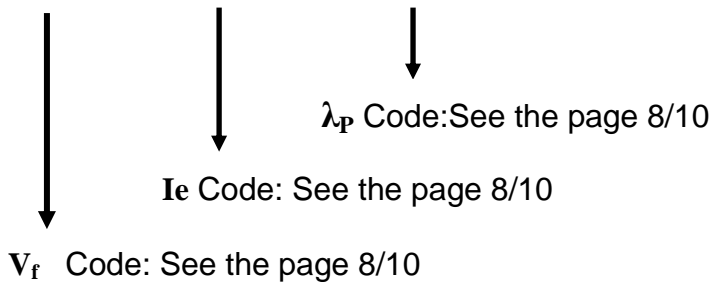

Drawing No.	Rev.	Date	Page
AG3535C-YRR-1000mA-H1	A	2022/06/01	3/10

Absolute Maximum Ratings at $T_a=25^{\circ}\text{C}$

Parameter	MAX.	Unit
DC forward current	1.5	A
Power Dissipation	4.95	W
Pulse Current	3	A
Reverse Voltage (V_R)	5	V
Junction temperature (T_j)	145	$^{\circ}\text{C}$
Electrostatic Discharge Classification(HBM)	2000	V
Operating Temperature Range	-40 $^{\circ}\text{C}$ to +125 $^{\circ}\text{C}$	
Storage Temperature Range	-55 $^{\circ}\text{C}$ to +125 $^{\circ}\text{C}$	
Lead Soldering Temperature	265 $^{\circ}\text{C}$ for 10 seconds	

Electrical and Optical Characteristics at $T_a=25^{\circ}\text{C}$

Parameter	Test Condition	Symbol	Min.	Typ.	Max.	Unit
Forward Voltage	$I_F=1000\text{mA}$	V_f	2.7	—	3.3	V
Reverse Current	$V_R=5\text{V}$	I_R	—	—	10	μA
Peak Wavelength	$I_F=1000\text{mA}$	λ_p	840	850	860	nm
Spectral Bandwidth (FWHM)	$I_F=1000\text{mA}$	$\Delta\lambda$	—	40	—	nm
Radiant Intensity	$I_F=1000\text{mA}$	I_e	430	—	580	mW/sr
Total Radiant Flux	$I_F=1000\text{mA}$	Φ_e	—	1550	—	mW
Thermal resistance	—	R_{j-s}	—	5	—	K/W
Rise/Fall Time	Rise and fall times of I_e (10% ~90%)	T_r/T_f	—	10/15	—	ns
Viewing Angle	—	$2\theta_{1/2}$	—	120	—	deg

Recommend forward current for longer duration is 1000mA.
These values measured by Spectrum Analyzer of SOLIDLITE.

Drawing No.	Rev.	Date	Page
AG3535C-YRR-1000mA-H1	A	2022/06/01	4/10

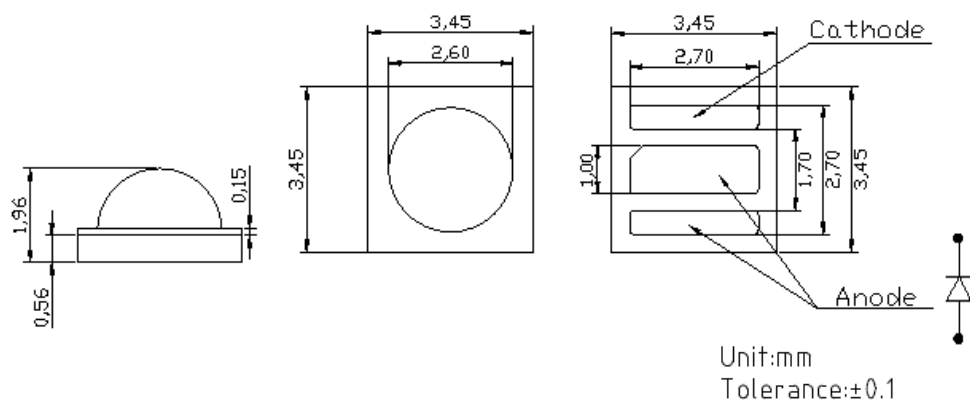
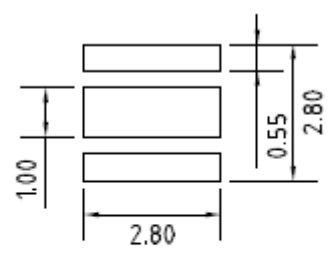
Package outline dimensions :	Recommended pad :
 <p>Unit:mm Tolerance:±0.1</p>	 <p>Unit:mm Tolerance:±0.1</p>

Surface Mounting Condition

In automatic mounting of the SMD IREDs on printed circuit boards, any bending , expanding and pulling forces or shock against the SMD IREDs shall be kept min. to prevent them from electrical failures and mechanical damages of the devices .

Soldering Reflow

Soldering of the SMD IREDs shall conform to the soldering condition in the individual specifications. SMD IREDs are designed for Reflow Soldering.

In the reflow soldering , too high temperature and too large temperature gradient such as rapid heating / cooling may cause electrical & optical failure and damages of the devices .

Solidlite can not guarantee the IRED after they have been assembled using the solder dipping method.

Recommended Soldering Temperature Time Profile (Reflow Soldering)

Lead Free Solder	
Pre-heat	150~200 ℃
Pre-heat time	120 sec. Max.
Peak-Temperature	245 ℃ Max.
Soldering time Condition	10 sec. Max.

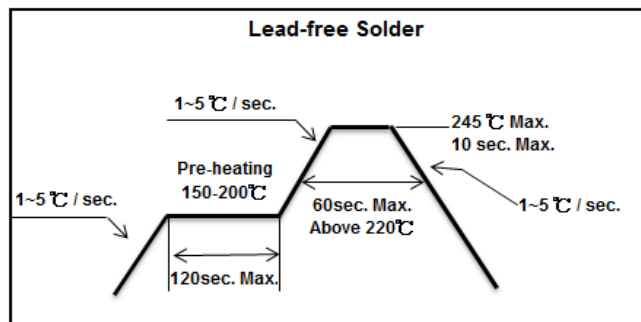

Drawing No.	Rev.	Date	Page
AG3535C-YRR-1000mA-H1	A	2022/06/01	5/10

Typical Electrical / Optical Characteristics Curves

(25°C Ambient Temperature Unless Otherwise Noted)

Relative Radiant Intensity & Ambient Temperature

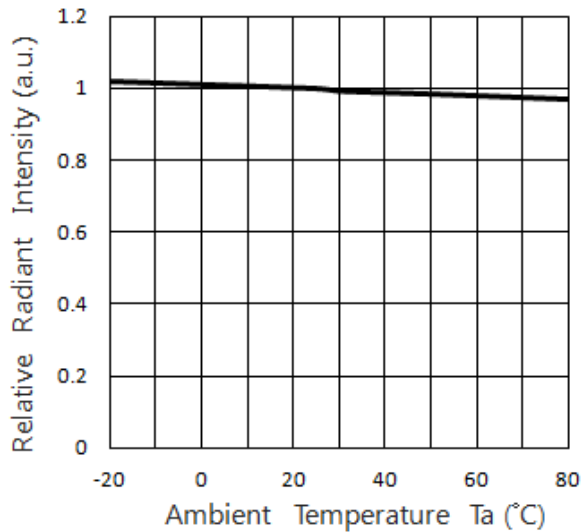

Relative Intensity VS. Forward Current

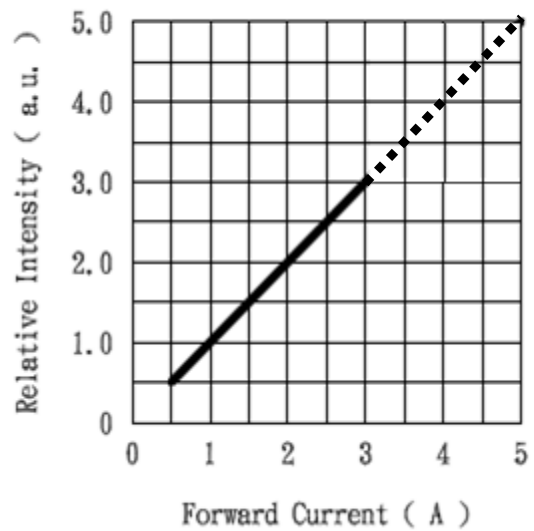

Forward Current & Ambient Temperature

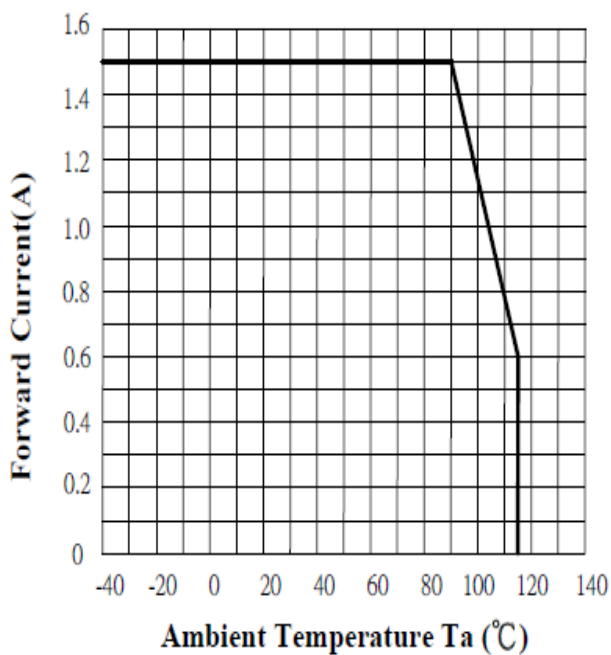

Forward Voltage vs Forward Current

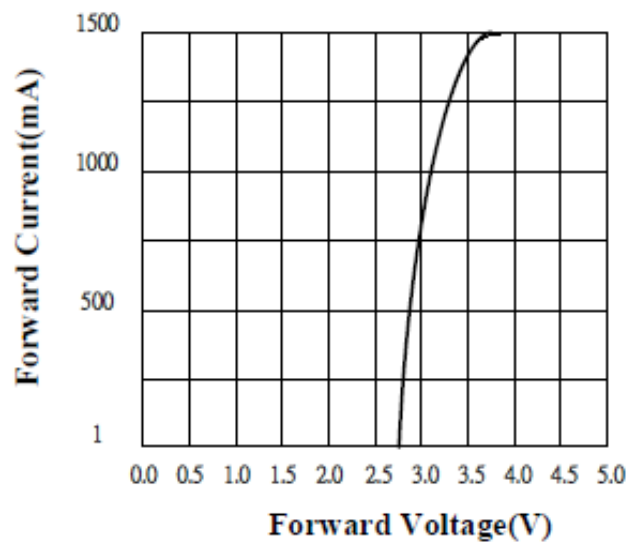

Drawing No.	Rev.	Date	Page
AG3535C-YRR-1000mA-H1	A	2022/06/01	6/10

Operating Range of Pulse Currents

(I_f vs. t_p , $T_a=25^\circ\text{C}$, "D" means Duty cycle)

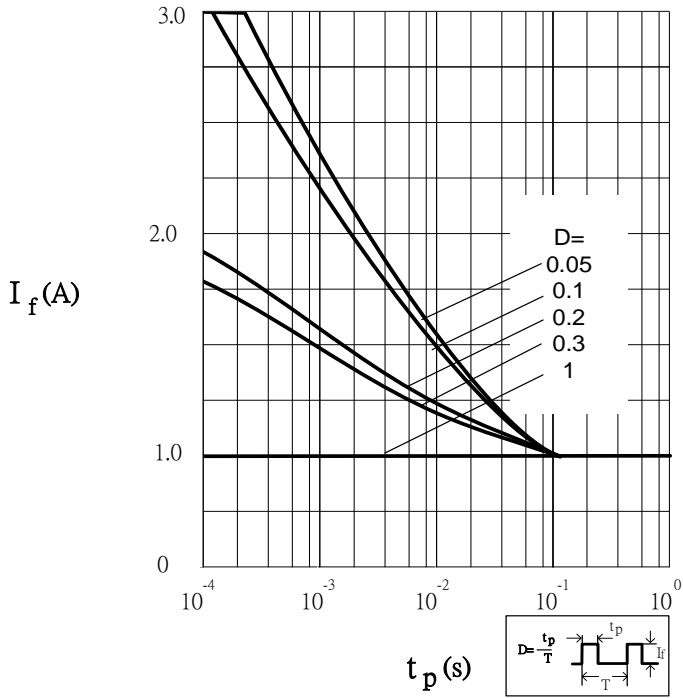

Relative Intensity vs Wavelength

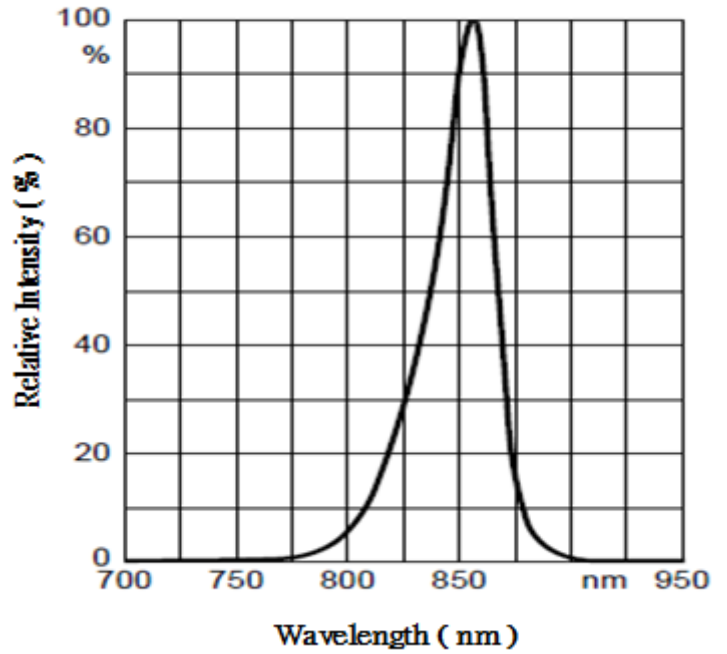

Spatial Distribution

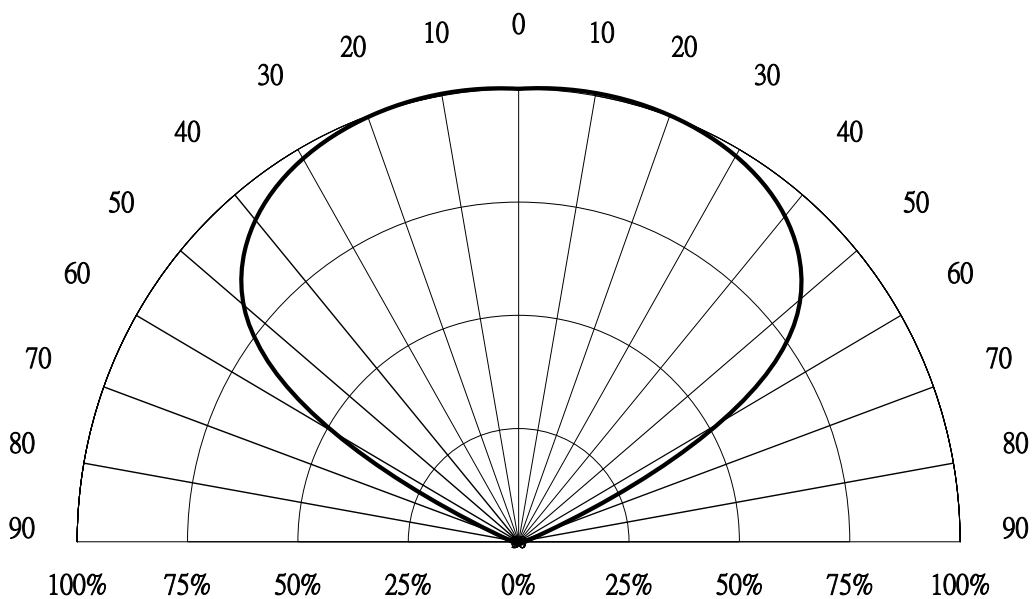

Drawing No.	Rev.	Date	Page
AG3535C-YRR-1000mA-H1	A	2022/06/01	7/10

Package Reel & Static Shielding Bag Dimensions :

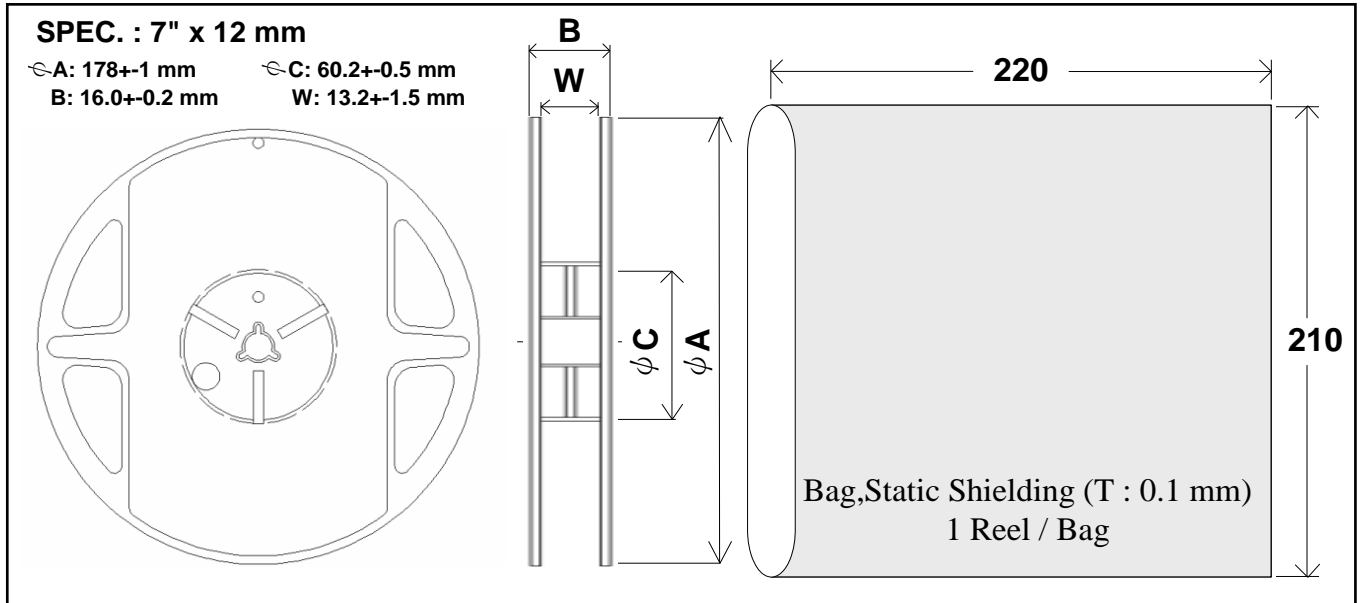

Package Carrier Tape Dimensions : 500 pcs/Reel

Dimensions. (Unit: mm)

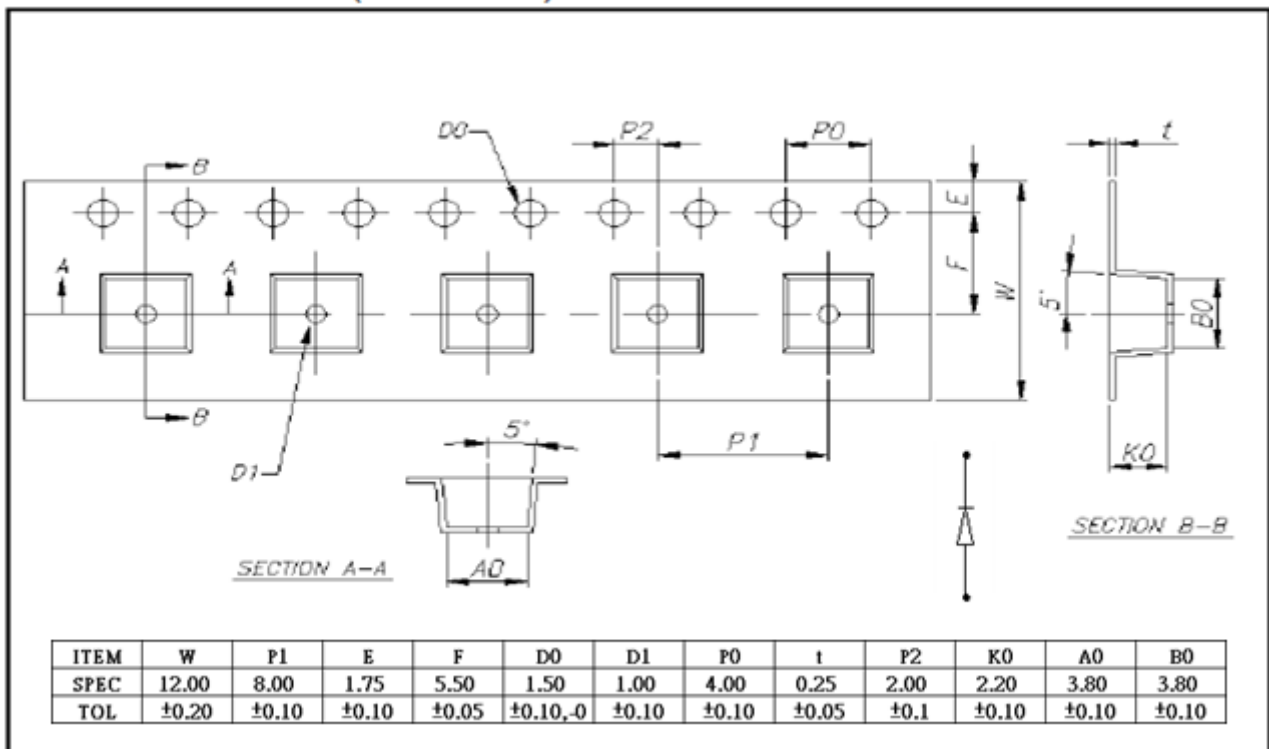

Drawing No.	Rev.	Date	Page
AG3535C-YRR-1000mA-H1	A	2022/06/01	8/10

Ranks Combination

V _f		A1	A2	A3
V _f @1000mA	(V)	2.7~2.9	2.9~3.1	3.1~3.3

Radiant Intensity		BC	BD	BE
I _e @1000mA	(mW/sr)	430~480	480~530	530~580

Peak Wavelength		C1	C2
λ _p @1000mA	(nm)	840~850	850~860

The quantity ratio of the ranks is decided by SOLIDLITE.

Note:

- 1.The products are sensitive to static electricity and care must be fully taken when handling products.
- 2.Measurement Uncertainty of the Radiant Intensity: ±10%
3. Measurement Uncertainty of the Peak Wavelength: ±1nm
4. Measurement Uncertainty of the Voltage: ±0.05V

Cautions :

1. Storage

*Storage Conditions

Before opening the package:

The IREDs should be kept at 30°C or less and 90%RH or less. The IREDs should be used within a year. When storing the IREDs, moisture proof packaging with absorbent material (silica gel) is recommended.

After opening the package:

The IREDs should be kept at 30°C or less and 70%RH or less. The IREDs should be soldered within 72 hours (3days) after opening the package. If unused IREDs remain, they should be stored in moisture proof packages, such as sealed containers with packages of moisture absorbent material (silica gel). It's also recommended to return the IREDs to the original moisture proof bag and to reseal the moisture proof bag again.

*If the moisture absorbent material (silica gel) has faded away or the IREDs have exceeded the storage time, baking treatment should be performed using the following condition.

Baking treatment: more than 24 hours at 65+/-5°C.



Drawing No.	Rev.	Date	Page
AG3535C-YRR-1000mA-H1	A	2022/06/01	9/10

*Solidlite IRED electrode sections are comprised of a silver plated copper alloy. The silver surface may be affected by environments which contain corrosive gases and so on. Please avoid conditions which may cause the IRED to corrode, tarnish or discolor. This corrosion or discoloration may cause difficulty during soldering operations. It is recommended that the user use the IREDs as soon as possible.

*Please avoid rapid transitions in ambient temperature, especially in high humidity environments where condensation can occur.

2. Moisture Proof Package

*When moisture is absorbed into the SMT package it may vaporize and expand during soldering. There is a possibility that this can cause exfoliation of the contacts and damage to the optical characteristics of the IREDs. For this reason, the moisture proof package is used to keep moisture to a minimum in the package.

*The moisture proof package is made of an aluminum moisture proof bag with a zipper. A package of a moisture absorbent material (silica gel) is inserted into the aluminum moisture proof bag. The silica gel changes its color from blue to pink as it absorbs moisture.

3. Heat Generation

*Thermal design of the end product is of paramount importance. Please consider the heat generation of the IRED when making the system design. The coefficient of temperature increase per input electric power is affected by the thermal resistance of the circuit board and density of IRED placement on the board, as well as other components. It is necessary to avoid intense heat generation and operate within the maximum ratings given in this specification.

*The operating current should be decided after considering the ambient maximum temperature of IREDs.

4. Static Electricity

*Static electricity or surge voltage damages the IREDs.

It is recommended that a wrist band or an anti-electrostatic glove be used when handling the IREDs.

*All devices, equipment and machinery must be properly grounded.

It is recommended that measures be taken against surge voltage to the equipment that mounts the IREDs.

*When inspecting the final products in which IREDs were assembled, it is recommended to check whether the assembled IREDs are damaged by static electricity or not. It is to find static-damaged IREDs by a light-on or a VF test at a lower current (below 1mA is recommended)

*Damaged IREDs will show some unusual characteristics such as the leak current remarkably increases, the forward voltage becomes lower, or the IREDs do not light at the low current.

5. Cleaning

*It is recommended that isopropyl alcohol be used as a solvent for cleaning the IREDs. When using other solvents, it should be confirmed beforehand whether the solvents will dissolve the package and the resin or not. Freon solvents should not be used to clean the IREDs because of worldwide regulations.

Drawing No.	Rev.	Date	Page
AG3535C-YRR-1000mA-H1	A	2022/06/01	10/10

*Do not clean the IREDs by the ultrasonic. When it is absolutely necessary, the influence of ultrasonic cleaning on the IREDs depends on factors such as ultrasonic power and the assembled condition. Before cleaning, a pre-test should be done to confirm whether any damage to the IREDs will occur.

6. Other

- *Care must be taken to ensure that the reverse voltage will not exceed the absolute maximum rating when using the IREDs with matrix drive.
- *The IREDs described in this brochure are intended to be used for ordinary electronic equipment (such as office equipment, communications equipment, measurement instruments and household appliances). Consult Solidlite's sales staff in advance for information on the applications in which exceptional quality and reliability are required, particularly when the failure or malfunction of the IREDs may directly jeopardize life or health (such as for airplanes, aerospace, submersible repeaters, nuclear reactor control systems, automobiles, traffic control equipment, life support systems and safety devices).
- *User shall not reverse engineer by disassembling or analysis of the IREDs without having prior written consent from Solidlite. When defective IREDs are found, the user shall inform Solidlite directly before disassembling or analysis.
- *The formal specifications must be exchanged and signed by both parties before large volume purchased begins.
- *The appearance and specifications of the product may be modified for improvement without notice.

Please follow the guideline to grab LEDs:

- **DO NOT** touch lens with fingers.
- **DO NOT** touch lens with tweezers.
- Use tweezers to grab LED(Shown as below).

